

0 600 873 003

Stand } 02-62

Issue } 02-05-13

Fig. /Abb. 2

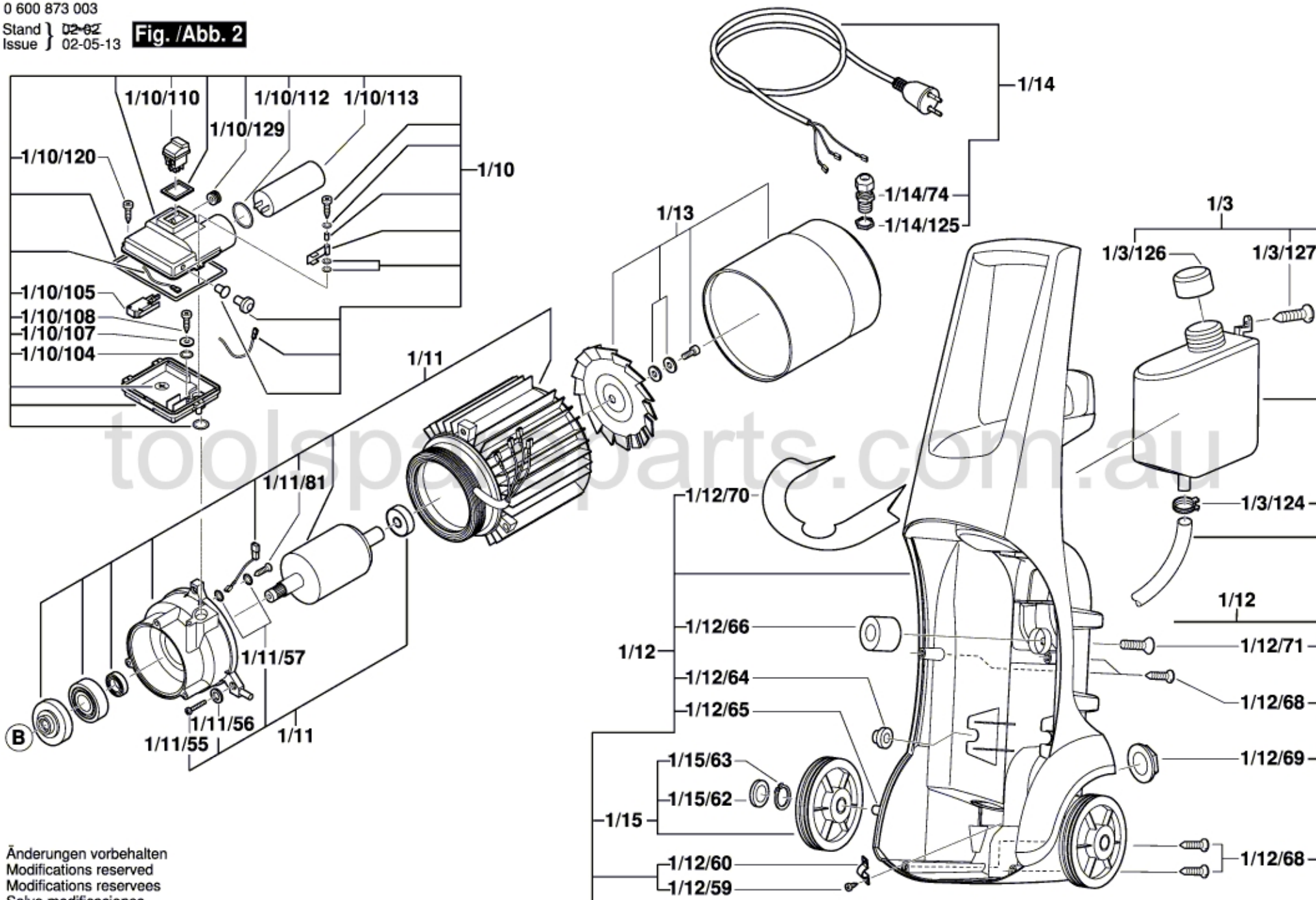

Änderungen vorbehalten
Modifications reserved
Modifications reserves
Salvo modificaciones